

Data Sheet



Article number: 586351923

Description: Valve 351.923, G 3/4" - G 3/4"
Thread/Thread

Measures

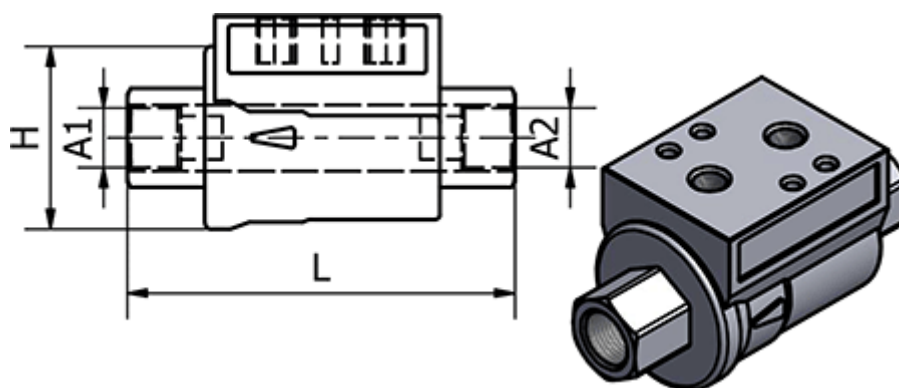

Connecting A1	= G 3/4"
Connecting A2	= G 3/4"
H	= 63.5
L	= 135
Max. Operating Pressure	= 10 bar
Seals	= FKM